

GO



OFFIC'E'

L'ufficio giorno
per giorno



GO Steel: le scrivanie con struttura in metallo.

- _GO Steel: the desks with metal structure.
- _GO Steel : les bureaux avec une structure en métal.
- _GO Steel: escritorios con estructura de metal.



GO Easy: le scrivanie con struttura pannellata.

- _GO Easy: the desks with paneled structure.
- _GO Easy : les bureaux avec une structure à panneaux.
- _GO Easy: escritorios con estructura de tableros.

GO



I nuovi mobili di sostegno, integrati con le scrivanie, ottimizzano lo spazio di contenimento.

- _The new support modular units, integrated with desks to optimize storage space.
- _Les nouveaux meubles de support, intégrés aux bureaux, optimisent l'espace de rangement.
- _Los nuevos muebles de soporte integrados con los escritorios optimizan el espacio a disposición.



Grigio Londra e Grigio Oxford ampliano la gamma di finiture per per piani, strutture e contenitori.

_The range of finishes for tops, structures and modular units has been expanded to include Grigio Londra and Grigio Oxford.

_Gris Londres et Gris Oxford élargissent la gamme de finitions pour les plans, les structures et les rangements.

_Grigio Londra y Grigio Oxford: la gama se amplía con estos acabados para tableros, estructuras y contenedores.

GO

1/5





I mobili lasciano spazio alla personalizzazione: possono essere infatti configurati scegliendo tra tantissime opzioni e completati con diversi accessori che ne sottolineano la grande flessibilità.

Furniture that can be easily customized: in fact, there is a choice of many options and various accessories for great flexibility.

Les meubles offrent toute latitude à la personnalisation : ils peuvent être configurés avec un large assortiment d'options et complétés par de nombreux accessoires qui en accentuent la flexibilité.

Muebles que dan lugar a la personalización: en efecto pueden configurarse de muchísimas maneras y completarse con distintos accesorios que destacan su gran versatilidad.





Il nuovo stile dell'arredo direzionale è elegante e dinamico, combina materiali diversi e si compone di strutture eclettiche: queste sono anche le caratteristiche del nuovo GO che interpreta in chiave contemporanea il più classico degli ambienti.

The new executive furnishing style is elegant and dynamic; it combines different materials and is composed of eclectic structures: these are also the characteristics of the New GO collection, to lend a contemporary air to the most classic of offices.

Le nouveau style du mobilier de direction est élégant et dynamique, il allie différents matériaux et se compose de structures éclectiques : voilà les caractéristiques du nouveau GO qui revisite dans une version contemporaine les espaces les plus classiques.

El nuevo estilo decorativo para ambientes ejecutivos es elegante y dinámico, combina distintos materiales y consta de estructuras eclécticas: estas son también las características del nuevo GO, que interpreta el más clásico de los ambientes en clave contemporánea.





Dai toni più scuri alle finiture più naturali, GO cambia volto grazie alla creatività e alle tante possibilità di scelta offerte da una gamma sempre aggiornata e attuale.

From darker tones to more natural finishes, GO changes personality thanks to creativity and to the many choices available in a range of products that is always up-to-date and modern.

Des tons plus sombres aux finitions plus naturelles, GO change de facette grâce à la créativité et aux nombreuses solutions offertes par une gamme toujours à jour et actuelle.

Desde las tonalidades más oscuras hasta los acabados más naturales, GO cambia de veste gracias a la creatividad y a las numerosas opciones que ofrece esta gama siempre actualizada y moderna.



Anche un direzionale deve soddisfare esigenze operative: il progetto GO si dimostra perfetto per raccontare i due volti di una collezione veramente smart.

Even an executive office must meet operational needs: The GO collection perfectly interprets the two faces of a truly smart collection.

Un espace de direction doit satisfaire aux exigences opérationnelles: le projet GO est parfait pour interpréter les deux facettes d'une collection vraiment intelligente.

Un ejecutivo también tiene que responder a exigencias operativas: el proyecto GO resulta ser perfecto para mostrar las dos caras de una colección decididamente smart.



Il sistema di elettrificazione del nuovo GO si evolve con l'elegante binario elettrificato, il top access e gli elementi di copertura nelle stesse finiture dei piani.

The wiring system of the new GO collection has been updated with an elegant electrified rail, the access top and the cover elements are in the same finish as the tops.

Le système d'électrification du nouveau GO évolue avec l'élégant rail électrifié, le top access et les éléments de couverture dans les finitions des plans.

El sistema de electrificación del nuevo GO evoluciona con la elegante guía electrificada, el "top access" y los elementos de cobertura en el mismo acabado de los tableros.

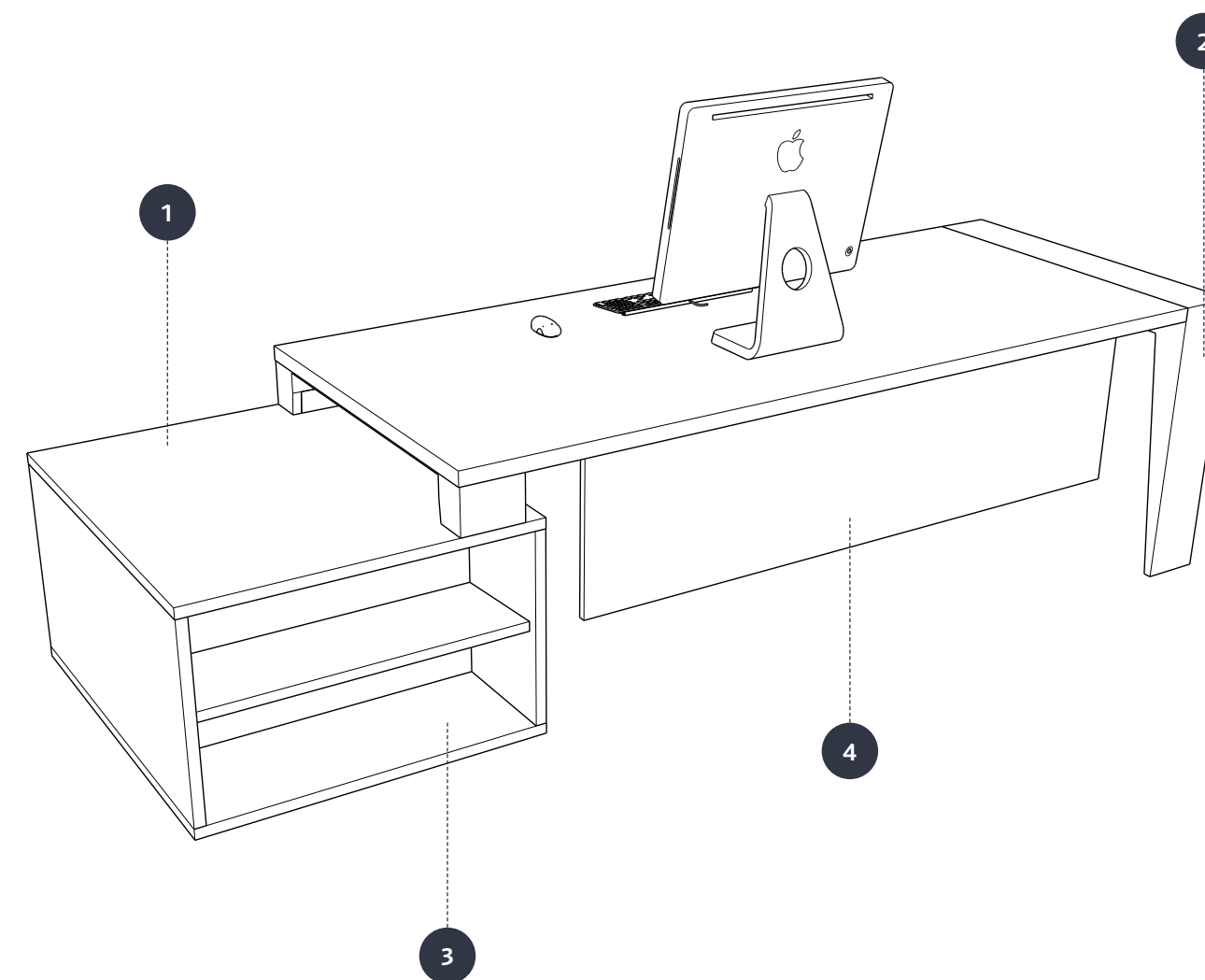

1 I mobili di servizio sono disponibili in tutte le finiture.

2 La gamba metallica ed i mobili di servizio sono coordinati e possono essere personalizzati creando piacevoli giochi di abbinamento colore-finitura.

3 Moduli a giorno, cassetti o vani porta CPU sono alcuni degli elementi che vanno a comporre il mobile di servizio.

4 Il modesty panel si integra perfettamente alla struttura grazie alle finiture con cui può essere personalizzato.

1 The service units are available in all of the finishes.

2 The metal leg and the service units are coordinated and can be customized using different color-finish combinations.

3 Open modular units, drawers or CPU stands are some of the elements that are used to compose the service unit.

4 The modesty panel blends perfectly with the structure thanks to the range of finishes available for customization.

1 Les meubles de service sont disponibles dans toutes les finitions.

2 Le pied métallique et les meubles de service sont coordonnés et peuvent être personnalisés en créant d'agréables jeux de couleur-finition.

3 Les modules ouverts, les tiroirs ou les compartiments porte-CPU sont quelques-uns des éléments qui composent le meuble de service.

4 Le modesty panel s'intègre parfaitement dans la structure grâce aux finitions avec lesquelles il peut être personnalisé.

1 Los muebles de servicio están disponibles en todos los acabados.

2 Los pies de soporte metálicos y los muebles de servicio están coordinados pueden personalizarse para crear agradables juegos de materiales y colores.

3 Módulos abiertos, cajones y compartimentos para CPU: algunos de los componentes del mueble de servicio.

4 El faldón se integra perfectamente a la estructura gracias a los acabados de personalización.





La scrivania può essere completata con un nuovo, pratico muretto con pensile.

The desk may be completed with a new, practical low wall with hanging unit.

Le bureau peut être complété par un nouveau muret avec élément haut.

El escritorio puede completarse con un nuevo tabique sumamente práctico, dotado de colgante.



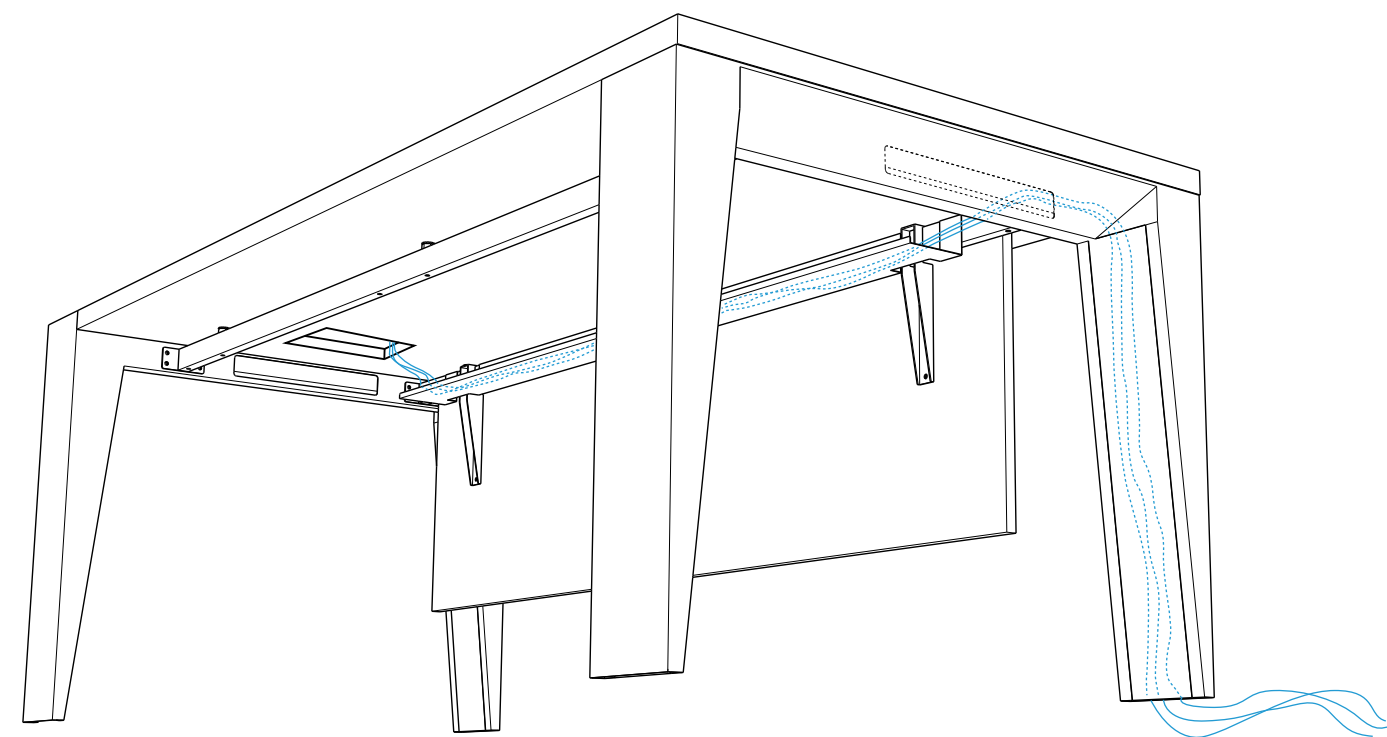

Carter apribile, cestello passacavi e top access facilitano la gestione dei cablaggi elettrici e informatici.

Removable casing, cable ducting box and access top facilitate management of electrical and computer wires.

Carter ouvrant, chemin de câbles et top access facilitent la gestion des câblages électriques et informatiques.

Cárter practicable, canal pasacables y "top access" para facilitar la colocación de los cables de datos y electricidad.





La cura dei particolari è importante: in Go anche gli elementi di copertura sono disponibili in tutte le finiture.

Attention to detail is important: in GO, even the cover elements are available in all the finishes of the range.

Le souci du détail est permanent : dans le modèle GO, les éléments de couverture sont, eux aussi, disponibles dans toutes les finitions.

Muy importante el cuidado de los detalles: en Go, hasta los elementos de cobertura pueden elegirse en todos los acabados.

GO

6/9



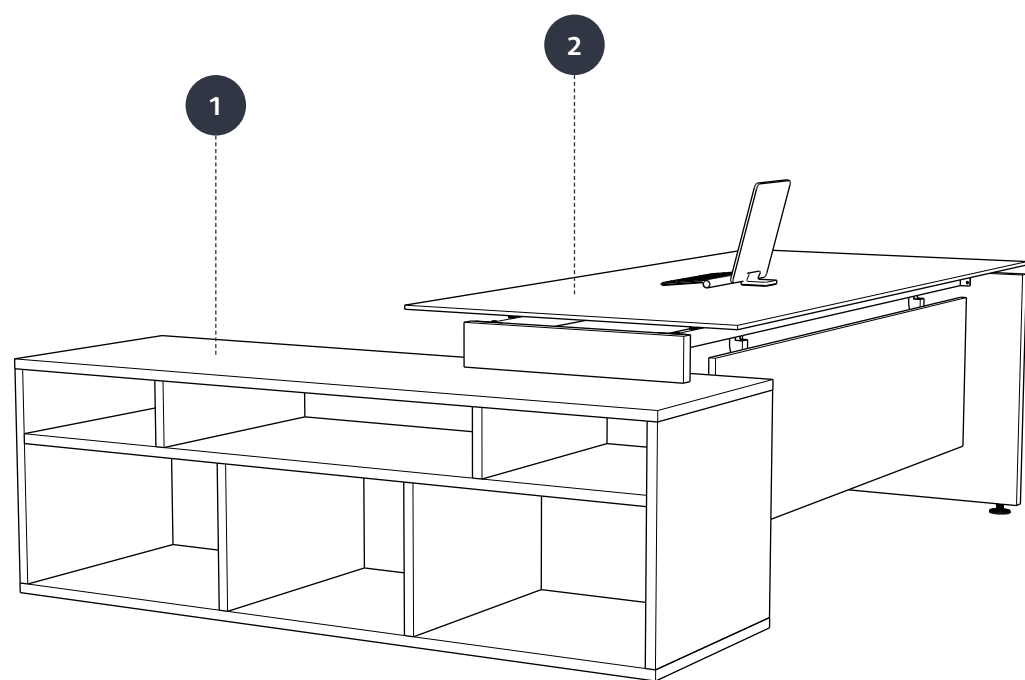

1 I mobili di servizio sono disponibili con varie configurazioni, ma anche in diverse dimensioni.

2 La gamma dei piani in vetro si amplia con le nuove finiture Grigio Londra e Grigio Oxford.

1 The service units are available in a variety of configurations, but also in different sizes.

2 The range of glass tops is expanded to include the new Grigio Londra and Grigio Oxford finishes.

1 Les meubles de service sont disponibles dans différentes configurations, mais aussi dans différentes dimensions.

2 La gamme des plans en verre s'élargit avec les nouvelles finitions Gris Londres et Gris Oxford.

1 Los muebles de servicio pueden elegirse en varias configuraciones, así como en varios tamaños.

2 La gama de tableros de cristal se amplía con los nuevos acabados Grigio Londra y Grigio Oxford.





Chiedere il massimo al proprio ambiente lavorativo si può: sfruttando ogni possibilità offerta dal sistema è facile arredare con stile senza dimenticare la razionalità.

Demand the maximum from your work space? Now you can: take advantage of every possibility the system offers to organize and furnish your work space with style.

Obtenir le maximum de son lieu de travail est possible : en exploitant toutes les possibilités offertes par le système, vous donnerez du style à votre pièce tout en optimisant la rationalité.

Con GO, es posible exigir lo máximo al propio ambiente de trabajo: gracias a todas las opciones del sistema podemos decorarlo con estilo sin descuidar la racionalidad.





Piano, sostegno pannellato e modesty panel possono essere personalizzati creando piacevoli combinazioni bicolore, giocando con finiture e fantasia.

Top, paneled support and modesty panel can be customized by creating beautiful two-color combinations using the available finishes and your imagination.

Plan, support à panneaux et modesty panel peuvent être personnalisés en créant d'agréables combinaisons bicolores, et en jouant avec les finitions et la fantaisie.

Tanto el tablero como la estructura de soporte y el faldón pueden personalizarse para crear agradables combinaciones bicolor jugando con los acabados y la imaginación.





2015 January

M	T	W	T	F	S	S
			1	2	3	4
5	6	7	8	9	10	11
12	13	14	15	16	17	18
19	20	21	22	23	24	25
26	27	28	29	30	31	



La nuova postazione front office trasforma una semplice scrivania in una perfetta area accoglienza, versatile e di grande impatto visivo.

The new front office station transforms a simple desk into the perfect reception desk, versatile and with great visual impact.

La nouvelle banque d'accueil transforme un simple bureau en un espace d'accueil parfait, polyvalent et avec un excellent rendu esthétique.

El nuevo front office transforma un simple escritorio en una perfecta área de recepción, versátil y de gran impacto visual.



GO

10





Anche i tavoli riunione sono disponibili con struttura metallica o pannellata: sagomature dei piani, finiture e accessori completano il layout senza compromessi in termini di componibilità.

Conference tables are also available with metal or paneled structures: the shapes of the tops, the finishes and accessories complete the layout with no compromises in terms of modularity.

Les tables de réunion sont, elles aussi, disponibles avec une structure métallique ou à panneaux : les façonnages des plans, les finitions et les accessoires complètent la configuration modulable.

También las mesas de reunión pueden elegirse con estructura metálica o de tableros: la configuración se completa con el moldurado del tablero, los acabados y los accesorios, sin necesidad de descuidar la modularidad.

INFORMAZIONI TECNICHE

Technical information

Datos técnicos

Renseignements techniques

GO EASY - SCRIVANIE PIANO IN MELAMINICO

GO EASY - Melamine desks tops / GO EASY - Bureaux plan en melamine / GO EASY - Escritorios con tablero de melamina

Scrivania lineare

Straight desk / Bureau linéaire / Escritorio lineal



L	P	H
160	90	75
180		
200		
L	P	H
100	60	75
120		
140		
160		

Scrivania ad angolo

Corner desk / Bureau d'angle / Escritorio rinconero



L	P	H
160	190	75
180		
200		

Scrivania con elemento a giorno

Desk with open element / Bureau avec élément ouvert / Escritorio con módulo abierto



L	P	H
160	90	75
180		
200		

Scrivania con sostegno a L

Desk with L-shaped support element / Bureau avec support en L / Escritorio con soporte en L Bureaux droits



L	P	H
200	90	75
220		
240		
L	P	H
200	190	75
220		
240		

Scrivania con mobile di sostegno

Desk with support modular unit / Bureau avec meuble de support / Escritorio con mueble de soporte



L	P	H
220	90	75
240		
260		

Scrivania con mobile di sostegno

Desk with support modular unit / Bureau avec meuble de support / Escritorio con mueble de soporte



L	P	H
220	178	75
240		
260		

Scrivania con mobile di sostegno

Desk with support modular unit / Bureau avec meuble de support / Escritorio con mueble de soporte



L	P	H
200	178	75
220		
240		

Scrivania con mobile di sostegno

Desk with support modular unit / Bureau avec meuble de support / Escritorio con mueble de soporte



L	P	H
200	181	75
220		
240		

Scrivania con pensile aggregato

Desk with attached hanging unit / Bureau avec élément haut rattaché / Escritorio con colgante agregado



L	P	H
160	190	75
180		
200		

NOME SAT: GOEASY_10

Piani, sostegni e mobili di sostegno

Tops, support elements and support modular units / Plans, supports et meubles de support / Tableros, estructuras de soporte y muebles de soporte

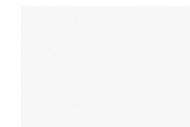

BIANCO OPACO
B17A



ACERO
AC2J



OLMO
LM7P



OLMO STORM
OS3Q

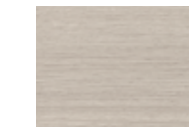

ROVERE PORTOFINO
RP5T

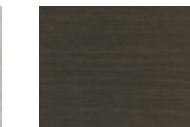

ROVERE GRIGIO
RG9D

Retro e pensile aggregato

Attached back and hanging unit / Arrière et élément haut rattaché / Trasera y colgante agregado

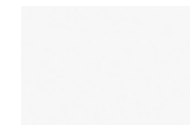

BIANCO OPACO
B17A



ACERO
AC2J



OLMO
LM7P



OLMO STORM
OS3Q

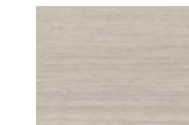

ROVERE PORTOFINO
RP5T

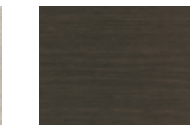

ROVERE GRIGIO
RG9D



GRIGIO OXFORD
GOST



GRIGIO LONDRA
GL7H

GO EASY - SCRIVANIE PIANO IN VETRO

GO EASY - Glass desks tops / GO EASY - Bureaux plan en verre / GO EASY - Escritorios con tablero de cristal

Scrivanie lineare

Straight desk / Bureau linéaire / Escritorio lineal



L	P	H
200	90	75

Scrivanie con sostegno a L

Desk with L-shaped support element / Bureau avec support en L / Escritorio con soporte en L Bureaux droits



L	P	H
240	90	75
L	P	H
240	190	75

Scrivanie con pensile aggregato

Desk with attached hanging unit / Bureau avec élément haut rattaché / Escritorio con colgante agregado



L	P	H
200	190	75

Scrivanie con mobile di sostegno

Desk with support modular unit / Bureau avec meuble de support / Escritorio con mueble de soporte



L	P	H
260	90	75

Scrivanie con mobile di sostegno

Desk with support modular unit / Bureau avec meuble de support / Escritorio con mueble de soporte



L	P	H
260	178	75

Scrivanie con mobile di sostegno

Desk with support modular unit / Bureau avec meuble de support / Escritorio con mueble de soporte



L	P	H
240	178	75

Scrivanie con mobile di sostegno

Desk with support modular unit / Bureau avec meuble de support / Escritorio con mueble de soporte



L	P	H
240	181	75

Piani vetro

Glass tops / Plans en verre / Tableros de cristal

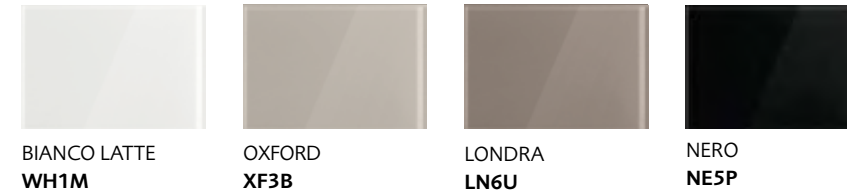

BIANCO LATTE
WH1M

OXFORD
XF3B

LONDRA
LN6U

NERO
NE5P

Sostegni e mobili di sostegno

Support elements and support modular units / Supports et meubles de support / Estructuras de soporte y muebles de soporte



BIANCO OPACO
BI7A

ACERO
AC2J

OLMO
LM7P

OLMO STORM
OS3Q

ROVERE PORTOFINO
RP5T

ROVERE GRIGIO
RG9D

Retro e pensile aggregato

Attached back and hanging unit / Arrière et élément haut rattaché / Trasera y colgante agregado



BIANCO OPACO
BI7A

ACERO
AC2J

OLMO
LM7P

OLMO STORM
OS3Q

ROVERE PORTOFINO
RP5T

ROVERE GRIGIO
RG9D



GRIGIO OXFORD
GOST



GRIGIO LONDRA
GL7H

GO STEEL - SCRIVANIE PIANO IN MELAMINICO

GO STEEL - Melamine desks tops / GO STEEL - Bureaux plan en melamine / GO STEEL - Escritorios con tablero de melamina

Scrivania lineare

Straight desk / Bureau linéaire / Escritorio lineal



L	P	H
180	90	75
200		
220		
L	P	H
100	60	75
120		
140		
160		

Scrivania ad angolo

Corner desk / Bureau d'angle / Escritorio rinconero



L	P	H
180	190	75
200		
220		

Scrivania con mobile di sostegno

Desk with support modular unit / Bureau avec meuble de support / Escritorio con mueble de soporte



L	P	H
240	90	75
260		
280		

Scrivania con mobile di sostegno

Desk with support modular unit / Bureau avec meuble de support / Escritorio con mueble de soporte



L	P	H
240	178	75
260		
280		

Scrivania con mobile di sostegno

Desk with support modular unit / Bureau avec meuble de support / Escritorio con mueble de soporte



L	P	H
220	178	75
240		
260		

Scrivania con mobile di sostegno

Desk with support modular unit / Bureau avec meuble de support / Escritorio con mueble de soporte



L	P	H
220	181	75
240		
260		

Scrivania con pensile aggregato

Desk with attached hanging unit / Bureau avec élément haut rattaché / Escritorio con colgante agregado



L	P	H
180	190	75
200		
220		

Piani e mobili di sostegno

Tops and support modular units / Plans et meubles de support / Tableros y muebles de soporte

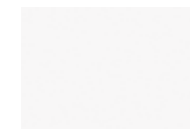

BIANCO OPACO
B17A



ACERO
AC2J



OLMO
LM7P



OLMO STORM
OS3Q

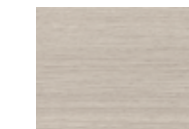

ROVERE PORTOFINO
RP5T

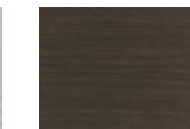

ROVERE GRIGIO
RG9D

Sostegni metallici

Metal support elements / Supports métalliques / Pies de soporte metálicos

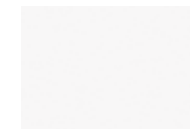

BIANCO OPACO
B17A
(RAL 9003)



GRIGIO OXFORD
GOST



GRIGIO LONDRA
GL7H

Pensile aggregato

Attached hanging unit / Élément haut rattaché / Colgante agregado

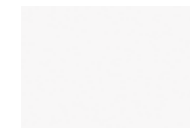

BIANCO OPACO
B17A



ACERO
AC2J



OLMO
LM7P



OLMO STORM
OS3Q

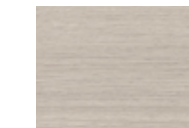

ROVERE PORTOFINO
RP5T

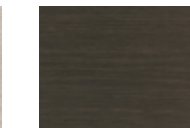

ROVERE GRIGIO
RG9D



GRIGIO OXFORD
GOST



GRIGIO LONDRA
GL7H

GO STEEL - SCRIVANIE PIANO IN VETRO

GO STEEL - Glass desks tops / GO STEEL - Bureaux plan en verre / GO STEEL - Escritorios con tablero de cristal

Scrivania lineare

Straight desk / Bureau linéaire / Escritorio lineal



L	P	H
200	90	75

Scrivania con mobile di sostegno

Desk with support modular unit / Bureau avec meuble de support / Escritorio con mueble de soporte



L	P	H
260	90	75

Scrivania con mobile di sostegno

Desk with support modular unit / Bureau avec meuble de support / Escritorio con mueble de soporte



L	P	H
260	178	75

Scrivania con mobile di sostegno

Desk with support modular unit / Bureau avec meuble de support / Escritorio con mueble de soporte



L	P	H
240	178	75

Scrivania con mobile di sostegno

Desk with support modular unit / Bureau avec meuble de support / Escritorio con mueble de soporte



L	P	H
240	181	75

Scrivania con pensile aggregato

Desk with attached hanging unit / Bureau avec élément haut rattaché / Escritorio con colgante agregado



L	P	H
240	190	75

Piani vetro

Glass tops / Plans en verre / Tableros de cristal



Sostegni metallici

Metal support elements / Supports métalliques / Pies de soporte metálicos



Mobili di sostegno

Support modular units / Meubles de support / Muebles de soporte



Pensile aggregato

Attached hanging unit / Élément haut rattaché / Colgante agregado

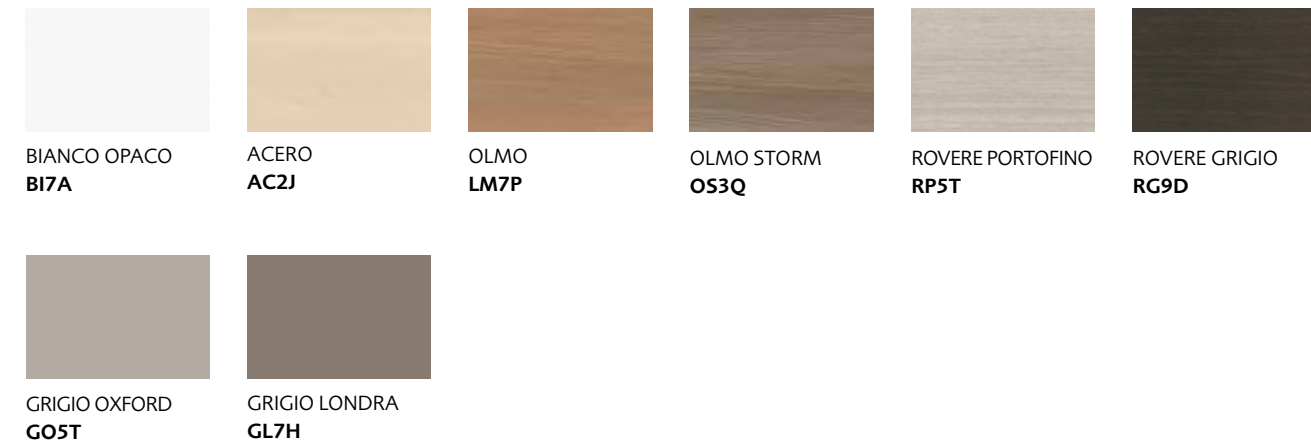

GO EASY - TAVOLI RIUNIONE

GO EASY - Conference tables / GO EASY - Tables de reunion / GO EASY - Mesas de reunion

Tavolo riunione sagomato

Shaped conference table / Table de réunion façonnée / Mesa de reunión moldurada



L	P	H
240	120	75

Tavolo riunione rettangolare

Rectangular conference table / Table de réunion rectangulaire / Mesa de reunión rectangular



L	P	H
240	120	75

Tavolo riunione rettangolare

Rectangular conference table / Table de réunion rectangulaire / Mesa de reunión rectangular



L	P	H
240	150	75
280		
320		

Tavolo riunione rettangolare

Rectangular conference table / Table de réunion rectangulaire / Mesa de reunión rectangular



L	P	H
360	150	75
400		

Piani e sostegni

Tops and support elements / Plans et supports / Tableros y estructuras de soporte

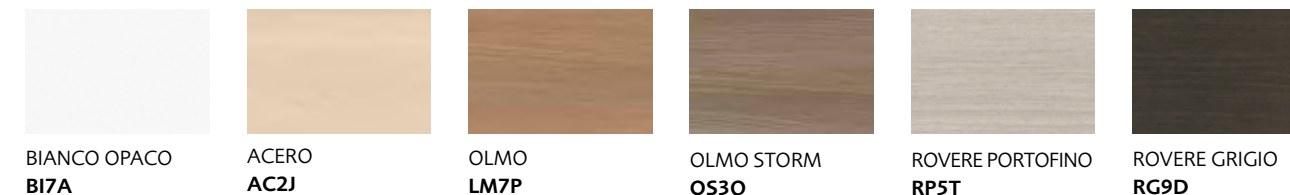

Retro e copertura

Back and cover / Arrière et couverture / Lado trasero y cubierta

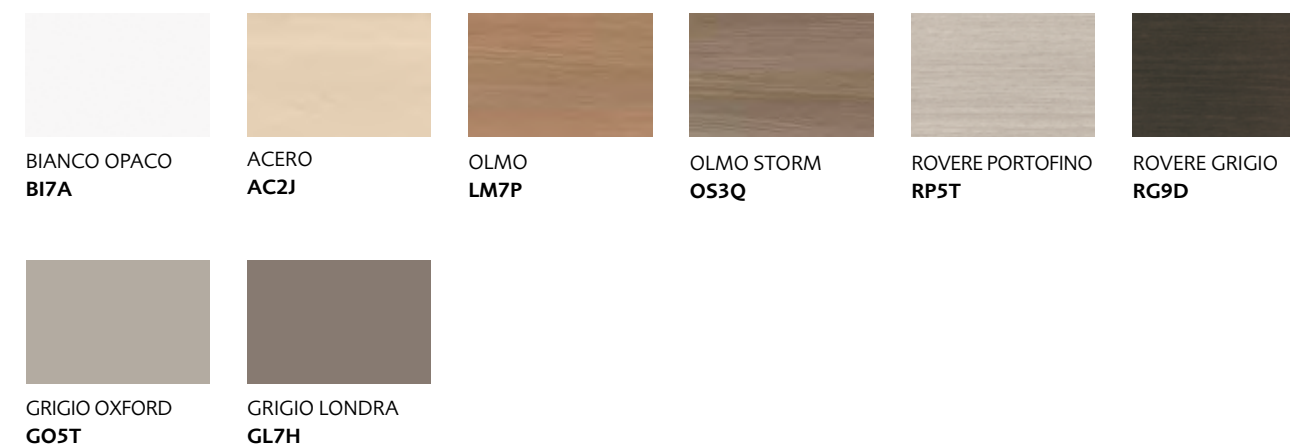

GO STEEL - TAVOLI RIUNIONE

GO STEEL - Conference tables / GO STEEL - Tables de reunion / GO STEEL - Mesas de reunion

Tavolo riunione sagomato

Shaped conference table / Table de réunion façonnée / Mesa de reunión moldurada



L	P	H
240	120	75

Tavolo riunione rettangolare

Rectangular conference table / Table de réunion rectangulaire / Mesa de reunión rectangular



L	P	H
240	120	75

Tavolo riunione quadrato

Square conference table / Table de réunion carrée / Mesa de reunión cuadrada



L	P	H
120	120	75

Tavolo riunione quadrato

Square conference table / Table de réunion carrée / Mesa de reunión cuadrada



L	P	H
150	150	75

Tavolo riunione rettangolare

Rectangular conference table / Table de réunion rectangulaire / Mesa de reunión rectangular



L	P	H
240	150	75
280		
320		
360		
400		

Tavolo riunione componibile

Modular conference table / Table de réunion modulable / Mesa de reunión modular



Tavolo riunione componibile

Modular conference table / Table de réunion modulable / Mesa de reunión modular



Piani

Tops / Encimeras / Plans

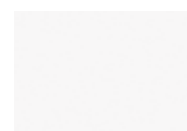

BIANCO OPACO
B17A



ACERO
AC2J



OLMO
LM7P



OLMO STORM
OS3Q

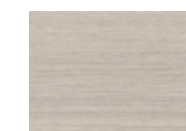

ROVERE PORTOFINO
RP5T

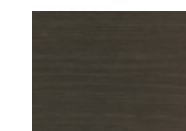

ROVERE GRIGIO
RG9D

Sostegni metallici

Metal support elements / Supports métalliques / Pies de soporte metálicos

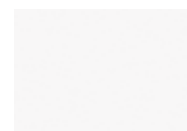

BIANCO OPACO
B17A
(RAL 9003)



GRIGIO OXFORD
G05T



GRIGIO LONDRA
GL7H

Copertura

Cover / Couverture / Cubierta

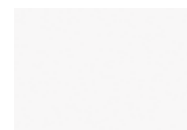

BIANCO OPACO
B17A



ACERO
AC2J



OLMO
LM7P



OLMO STORM
OS3Q



ROVERE PORTOFINO
RP5T

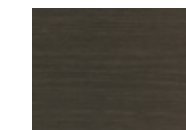

ROVERE GRIGIO
RG9D



GRIGIO OXFORD
G05T



GRIGIO LONDRA
GL7H

GO EASY/STEEL - MODESTY PANEL

GO EASY/STEEL - Modesty panel / GO EASY/STEEL - Modesty panel / GO EASY/STEEL - Modesty panel

Scrivania con mobile di sostegno

Desk with support modular unit / Bureau avec meuble de support / Escritorio con mueble de soporte



L	P	H
132	1,8	44,7
152	1,8	44,7
172	1,8	44,7

Scrivania lineare

Straight desk / Bureau linéaire / Escritorio lineal



L	P	H
140	1,8	44,7
160	1,8	44,7
180	1,8	44,7

Scrivania con mobile di sostegno

Desk with support modular unit / Bureau avec meuble de support / Escritorio con mueble de soporte



L	P	H
140	1,8	44,7
160	1,8	44,7
180	1,8	44,7

Modesty panel

Modesty panel / Modesty panel / Modesty panel

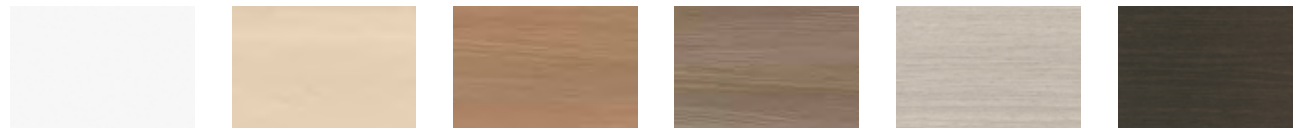

BIANCO OPACO
B17A

ACERO
AC2J

OLMO
LM7P

OLMO STORM
OS3Q

ROVERE PORTOFINO
RP5T

ROVERE GRIGIO
RG9D



GRIGIO OXFORD
GOST

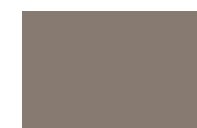

GRIGIO LONDRA
GL7H

MANIGLIE

Handles / Tiradores / Poignées



SNIP



SEL



LIG



ROD



RAN



CUT



LON

ACCESSORI

Accessories / Accesorios / Accessoires



Top access
Access top
Top access
Top access



L	P	H
26,4	12,4	5,2



Colonna elettrificata
Electrified unit
Piètem électrique
Columna electrificada



Binario elettrificato e adattatori
Electrified rail and adapters
Rail électrifié et adaptateurs
Guía electrificada y adaptadores



L	P	H
43,5	7,5	3,5



Passacavo accessoriato
Cable ducting system with accessories
Chemin de câble équipé
Pasacables con accesorios

CASSETTIERE

Chest of drawers / Muebles de sustentación / Meubles de soutènement



L	P	H
41,8	54,6	53,8



L	P	H
41,8	54,6	59,6



Cassettiere

Bearing units / Muebles de sustentación / Meubles de soutènement

Cassa

Carcase / Estructura / Structure



ALLUMINIO
AL1A

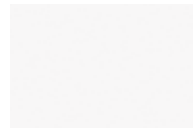

BIANCO OPACO
BI7A

Top e frontali

Top and front parts / Paneles superiores y frontales / Top et façades



ALLUMINIO
AL1A

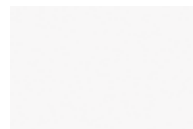

BIANCO OPACO
BI7A



ACERO
AC2J



OLMO
LM7P



OLMO STORM
OS3Q



ROVERE PORTOFINO
RP5T

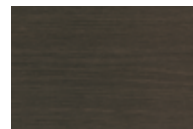

ROVERE GRIGIO
RG9D

Cassettiere integrali

Whole drawer units / Cajoneras integrales / Tiroirs internes intégraux

Cassa, top e frontali

Carcase, top and front parts / Estructura, paneles superiores y frontales / Structure, top et façades



ACERO
AC2J



OLMO
LM7P



OLMO STORM
OS3Q



ROVERE PORTOFINO
RP5T

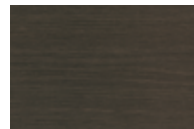

ROVERE GRIGIO
RG9D

MOBILE DI SERVIZIO CON PIEDI

Service modular unit with feet / Meuble de service avec pieds / Mueble de servicio con patas



L	P	H
93,8	59,7	60,5
138,8		
183,8		

Cassa

Carcase / Estructura / Structure

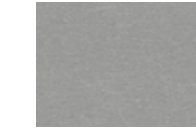

ALLUMINIO
AL1A

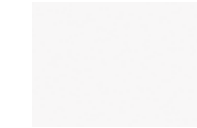

BIANCO OPACO
BI7A

Struttura, facciate e retri

Structure, fronts and backs / Structure, façades et arrières / Estructura, frentes y lados traseros



ALLUMINIO
AL1A

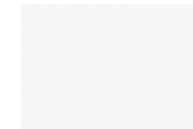

BIANCO OPACO
BI7A



ACERO
AC2J



OLMO
LM7P



OLMO STORM
OS3Q



ROVERE PORTOFINO
RP5T

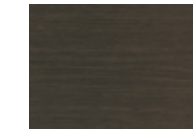

ROVERE GRIGIO
RG9D

MOBILE DI SERVIZIO SU RUOTE

Service modular unit on wheels / Meuble de service sur roulettes / Mueble de servicio con ruedas



L	P	H
93,8	59,7	69,3
138,8	59,7	69,3
183,8	59,7	69,3

Cassa

Carcase / Estructura / Structure



ALLUMINIO
AL1A

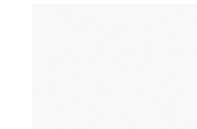

BIANCO OPACO
BI7A

Struttura e facciate

Structure and front / Estructura y frentes / Etructure et façades



ALLUMINIO
AL1A

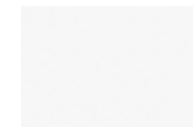

BIANCO OPACO
BI7A



ACERO
AC2J



OLMO
LM7P



OLMO STORM
OS3Q



ROVERE PORTOFINO
RP5T

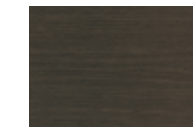

ROVERE GRIGIO
RG9D

LIBRERIA 2SIDE

2Sided bookshelf / librería 2Side / bibliothèque 2Side

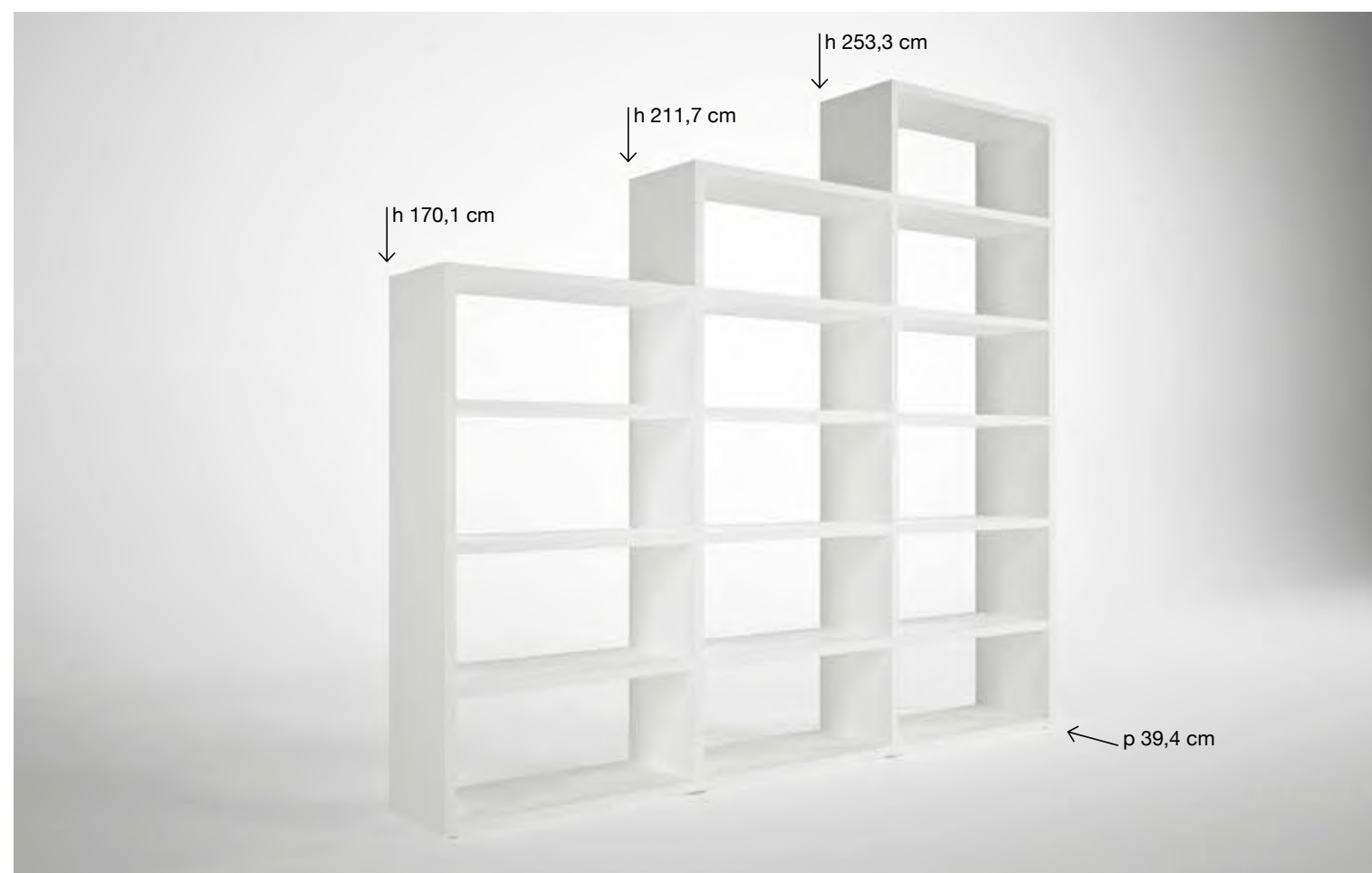

ARMADI CON ANTA LIBRO

Unit with folding door / Armarios con puerta "libro" / Armoires avec portes accordéon



ARMADI CON ANTA BATTENTE

Hinged door wardrobes / Armarios de puerta batiente / Armoires porte a battant



ARMADI CON ANTA SCORREVOLE

Sliding door wardrobes / Armarios de puerta corredera / Armoires porte coulissante



ANTA BATTENTE IN PANNELLO - ANTA 30/60

hinged panel door - door 30/60 / puertas batientes de panel - puerta 30/60 / portes battantes en panneau - porte 30/60



L	P	H				
		76,8	115,2	153,6	192	230,4
45	45	76,8	115,2	153,6	192	230,4
90	45	76,8	115,2	153,6	192	230,4
(*) 180	45	76,8	115,2	153,6	192	230,4
(*) 270	45	76,8	115,2	153,6	192	230,4
45	35	76,8	115,2	153,6	192	230,4
90	35	76,8	115,2	153,6	192	230,4
(*) 180	35	76,8	115,2	153,6	192	230,4
(*) 270	35	76,8	115,2	153,6	192	230,4

(*) Cassa disponibile solo in alluminio.
 Non disponibili ante 30-60 /
 Structure available only in aluminium,
 Doors 30-60 not available;
 Estructura disponible sólo de aluminio.
 Puertas 30-60 no disponible.
 Structure disponible uniquement en aluminium.
 Porte 30-60 non disponible.



Cassa

Carcase / Estructura / Structure



ALLUMINIO
AL1A

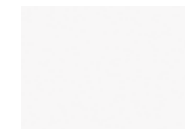

BIANCO OPACO
BI7A



ACERO
AC2J



OLMO
LM7P

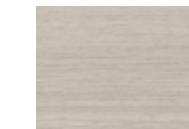

ROVERE PORTOFINO
RP5T

Ante opache

Matt doors / Puertas opacas / Portes mates



ALLUMINIO
AL1A

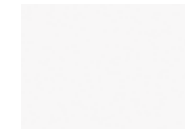

BIANCO OPACO
BI7A



ACERO
AC2J



OLMO
LM7P



OLMO STORM
OS3Q



ROVERE PORTOFINO
RP5T

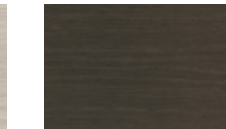

ROVERE GRIGIO
RG9D



GRIGIO OXFORD
GO5T



GRIGIO LONDRA
GL7H

Ante lucide

Glossy doors / Puertas brillantes / Portes brillantes

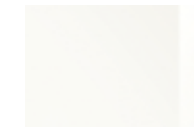

BIANCO LUX
BX3J

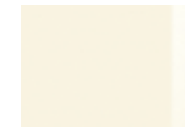

AVORIO LUX
AX1K



VISONE LUX
VL4C

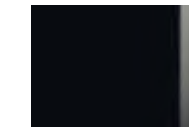

NERO LUX
NX5Y

ANTA BATTENTE IN VETRO TRASPARENTE

Transparent glass hinged door / Puerta batiente de vidrio transparente / porte battante en verre transparent



L	P	H			
45	45	76,8	115,2	153,6	192
90	45	76,8	115,2	153,6	192
(*) 180	45	76,8	115,2	153,6	192
(*) 270	45	76,8	115,2	153,6	192
45	35	76,8	115,2	153,6	192
90	35	76,8	115,2	153,6	192
(*) 180	35	76,8	115,2	153,6	192
(*) 270	35	76,8	115,2	153,6	192

(*) Cassa disponibile solo in alluminio /
Casing available only in aluminium /
Caja disponible sólo en aluminio /
Caisse disponible uniquement en aluminium

Cassa
Carcase / Estructura / Structure



ALLUMINIO AL1A BIANCO OPACO BI7A ACERO AC2J OLMO LM7P ROVERE PORTOFINO RP5T

Anta
Doors / Puertas / Portes

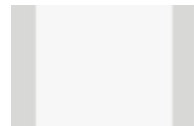

TRASPARENTE TR9M

ANTA BATTENTE IN VETRO CON TELAIO IN ALLUMINIO

Glass hinged door with aluminium frame / Puerta batiente de cristal / Porte battante en verre



L	P	H			
45	45	76,8	115,2	153,6	192
90	45	76,8	115,2	153,6	192
(*) 180	45	76,8	115,2	153,6	192
(*) 270	45	76,8	115,2	153,6	192
45	35	76,8	115,2	153,6	192
90	35	76,8	115,2	153,6	192
(*) 180	35	76,8	115,2	153,6	192
(*) 270	35	76,8	115,2	153,6	192

(*) Cassa disponibile solo in alluminio /
Casing available only in aluminium /
Caja disponible sólo en aluminio /
Caisse disponible uniquement en aluminium

Cassa
Carcase / Estructura / Structure



ALLUMINIO AL1A BIANCO OPACO BI7A ACERO AC2J OLMO LM7P ROVERE PORTOFINO RP5T

Anta
Doors / Puertas / Portes



BRI BR1L BIANCO LATTE WH1M RED RE4L NERO NE5P

ANTA LIBRO

Folding door / Puerta ap. "de libro" / Porte accordéon



L	P	H				
(*) 180	45	82,8	121,2	159,6	198	236,4

(*) Cassa disponibile solo in alluminio /
Casing available only in aluminium /
Caja disponible sólo en aluminio /
Caisse disponible uniquement en aluminium



Cassa
Carcase / Estructura / Structure

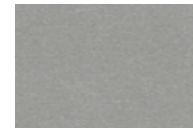

ALLUMINIO
AL1A

Ante opache

Matt doors / Puertas opacas / Portes mates



ALLUMINIO AL1A BIANCO OPACO B17A ACERO AC2J OLMO LM7P OLMO STORM OS3Q ROVERE PORTOFINO RP5T ROVERE GRIGIO RG9D



GRIGIO OXFORD G05T GRIGIO LONDRA GL7H

Ante lucide

Glossy doors / Puertas brillantes / Portes brillantes



BIANCO LUX BX3J AVORIO LUX AX1K VISONE LUX VL4C NERO LUX NX5Y

ANTA SCORREVOLE IN PANNELLO

Panel sliding door / Puerta corredera en el panel / Porte coulissante en panneau



L	P	H			
182,5	45,6	84,6	123	161,4	199,8
271,3	45,6	84,6	123	161,4	199,8



Cassa
Carcase / Estructura / Structure

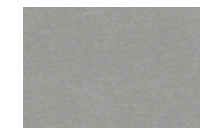

ALLUMINIO
AL1A

Ante opache

Matt doors / Puertas opacas / Portes mates



ALLUMINIO AL1A BIANCO OPACO B17A ACERO AC2J OLMO LM7P OLMO STORM OS3Q ROVERE PORTOFINO RP5T ROVERE GRIGIO RG9D

Ante lucide

Glossy doors / Puertas brillantes / Portes brillantes



BIANCO LUX BX3J AVORIO LUX AX1K VISONE LUX VL4C NERO LUX NX5Y

ANTA SCORREVOLE CON INSERTO

Sliding door with insert / Puerta corredera con inserto / Porte coulissante avec élément



L	P	H	
182,5	45,6	161,4	199,8
271,3	45,6	161,4	199,8

Alcuni esempi di composizione
Suggested compositions
Ejemplos de composición
Exemples de composition



Cassa
Carcase / Estructura / Structure



ALLUMINIO
AL1A

Inserto lucido
Glossy insert / Detalle brillante / Bande brillante

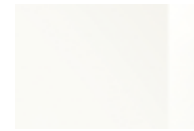

BIANCO LUX
BX3J



AVORIO LUX
AX1K



VISONE LUX
VL4C



NERO LUX
NX5Y

Inserto opaco
Matt insert / Detalle opaco / Bande opaque



ALLUMINIO
AL1A

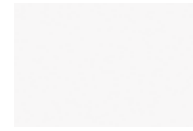

BIANCO OPACO
BI7A



ACERO
AC2J



OLMO
LM7P



OLMO STORM
OS3Q



ROVERE PORTOFINO
RP5T



ROVERE GRIGIO
RG9D

ANTA SCORREVOLE IN VETRO CON TELAIO IN ALLUMINIO

Glass sliding door with aluminium frame / Puerta corredera de cristal con estructura de aluminio / Porte coulissante en verre avec cadre en aluminium



L	P	H			
182,5	45,6	84,6	123	161,4	199,8
271,3	45,6	84,6	123	161,4	199,8

Cassa
Carcase / Estructura / Structure

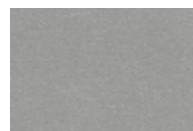

ALLUMINIO
AL1A

Anta
Doors / Puertas / Portes



BRI
BR1L

BASI PER ARMADIO

Base units for wardrobe / Bases para armario / Bases pour armoire



Basi per armadi P45
Base units for wardrobe P45
Bases para armario P45
Bases pour armoire P45

L	P	H
259,8	47,9	6,5
214,8	47,9	6,5
169,8	47,9	6,5

Basi per armadi P35
Base units for wardrobe P35
Bases para armario P35
Bases pour armoire P35

L	P	H
169,8	37,9	6,5
214,8	37,9	6,5
259,8	37,9	6,5

Ante opache
Matt doors / Puertas opacas / Portes mates



ACERO
AC2J



OLMO
LM7P



OLMO STORM
OS3Q



ROVERE PORTOFINO
RP5T



ROVERE GRIGIO
RG9D

KIT DI FINITURA

Finishing kit / Kit de revestimiento / Kit de revêtement



L	P	H				
(*) 45	45,6	76,8	115,2	(*)153,6	(*) 192	(*) 230,4
(*) 90	45,6	76,8	115,2	(*)153,6	(*) 192	(*) 230,4
(*) 135	45,6	76,8	115,2	(*)153,6	(*) 192	(*) 230,4
(*) 180	45,6	76,8	115,2	(*)153,6	(*) 192	(*) 230,4
(*) 225	45,6	76,8	115,2	(*)153,6	(*) 192	(*) 230,4
270	45,6	76,8	115,2	(*)153,6	(*) 192	(*) 230,4
(*) 45	35,6	76,8	115,2	(*)153,6	(*) 192	(*) 230,4
(*) 90	35,6	76,8	115,2	(*)153,6	(*) 192	(*) 230,4
(*) 135	35,6	76,8	115,2	(*)153,6	(*) 192	(*) 230,4
(*) 180	35,6	76,8	115,2	(*)153,6	(*) 192	(*) 230,4
(*) 225	35,6	76,8	115,2	(*)153,6	(*) 192	(*) 230,4
270	35,6	76,8	115,2	(*)153,6	(*) 192	(*) 230,4

(*) Lunghezze e altezze disponibili per kit lucidi.
Available length and height of glossy kit
Largos y alturas disponibles para kits brillantes
Longueurs et hauteurs disponibles pour kits brillants

Top e fianchi di finitura opachi

Top and matt finishing side panels / Encimera y costados de terminación opacos / Plateau et joues latérales opaques



ALLUMINIO
AL1A

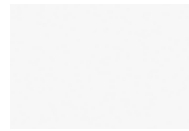

BIANCO OPACO
B17A



ACERO
AC2J



OLMO
LM7P



OLMO STORM
OS3Q



ROVERE PORTOFINO
RP5T



ROVERE GRIGIO
RG9D



GRIGIO OXFORD
GOST



GRIGIO LONDRA
GL7H

Top e fianchi di finitura lucidi

Top and glossy finishing side panels / Encimera y costados de terminación brillantes / Plateau et joues latérales brillants

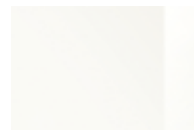

BIANCO LUX
BX3J

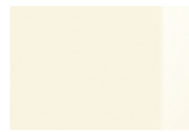

AVORIO LUX
AX1K



VISONE LUX
VL4C



NERO LUX
NX5Y

LIBRERIA MILTON

Milton bookcase / Estantería milton / Bibliotheque milton



L	P	H
77,5	30,7	78
115,3	30,7	115,8

Cassa

Carcase / Estructura / Structure

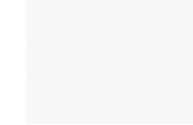

BIANCO OPACO
B17A

MONOBLOCCO

Single unit / Monobloque / Monobloc



L	P	H
155	60	217,6
185	60	217,6

Cassa

Carcase / Estructura / Structure

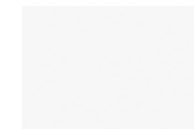

BIANCO OPACO
B17A

Ante opache

Matt doors / Puertas opacas / Portes mates

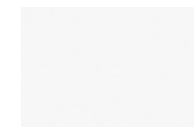

BIANCO OPACO
B17A



OLMO
LM7P



OLMO STORM
OS3Q

Maniglia monoblocco

Single-casting handle / Tirador monobloque / Poignée monobloc



CLICK

Ricerca e coordinamento

Colombini S.p.A.

Design ed art direction

Eikon

Progetto grafico

Eikon

Fotografia

Eikon

Fotolito

MIC Studio

Stampa

Tecnostampa

La Colombini S.p.A. si riserva
di apportare, senza alcun preavviso,
le modifiche che riterrà più opportune
al fine di migliorare il prodotto.

OFFIC'E'

COLOMBINI S.p.A.

Azienda certificata UNI EN ISO 9001:2008
Azienda certificata UNI EN ISO 14001:2004
Strada Ca' Valentino, 124
47891 - Falciano - Repubblica di San Marino

Telefono da Italia 0549 975 611
Fax da Italia 0549 975 778
Phone from abroad +378 975 948
Fax from abroad +378 975 955

www.officcolombinigroup.com
<http://b2b.colombinigroup.com>

OFFIC'E' Go set-15 - 019U0002